

EI-4200

6+

SIMPLE CIRCUITS | BIG IMAGINATION

CIRCUIT EXPLORER™

ROCKET

MISSION GUIDE



WARNING:

CHOKING HAZARD—Small parts.
Not for children under three (3) years.



WARNING:

This toy produces flashes that may
trigger epilepsy in sensitized individuals.

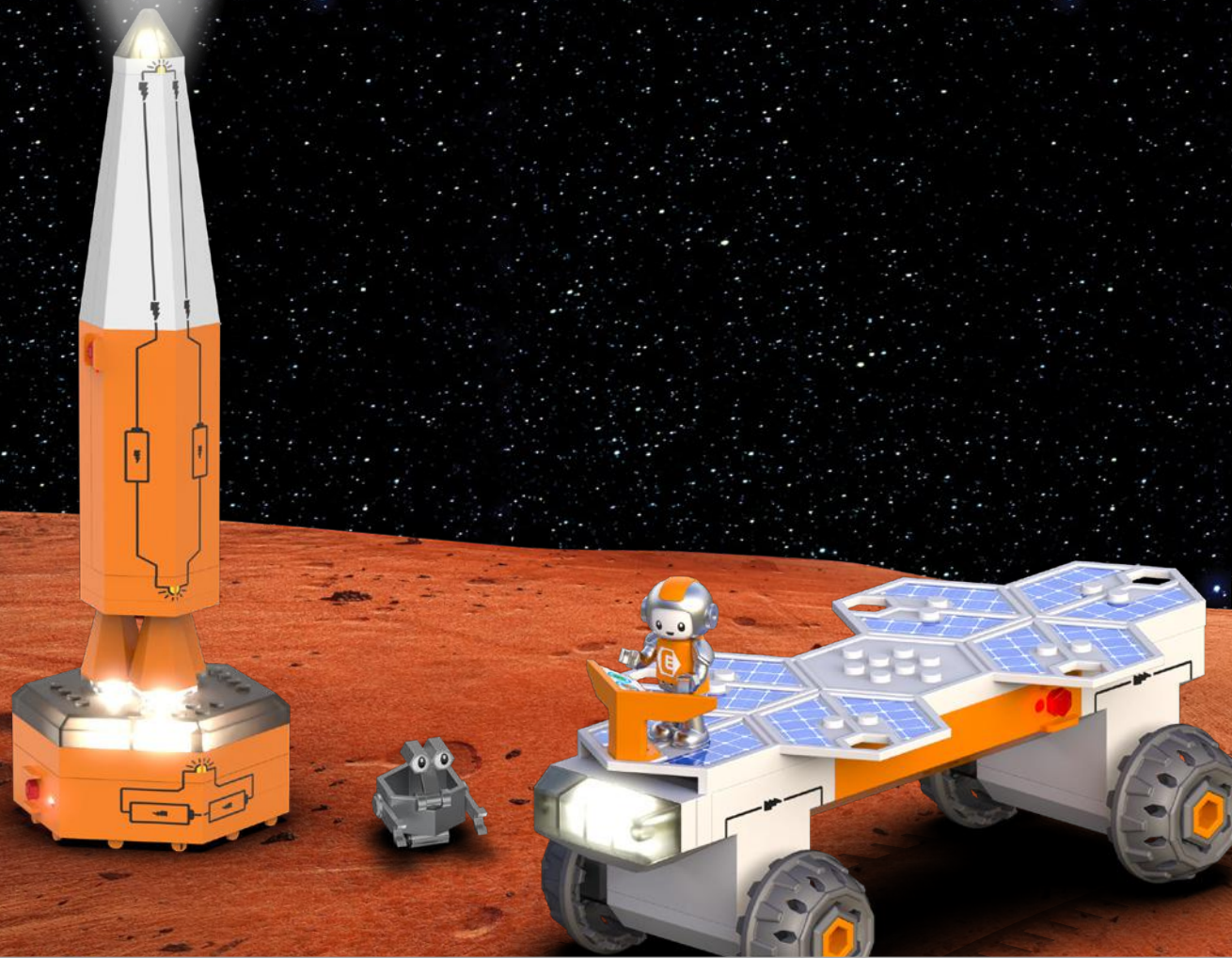

Welcome Explorer!

You made it to Mars! Your outpost is equipped with supplies to build the things you will need.

Follow these instructions to construct a rocket, launchpad, and a rover to explore the surface. We're relying on your engineering skills to create closed circuits to bring light to our mission.

Good luck!



Parts Checklist



L3

1x



A5

1x



A4

1x



N4

1x



L5

1x

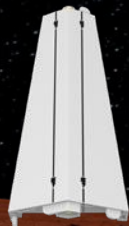

C2

1x



N3

1x

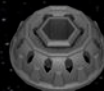

T1

4x



L2

1x



L1

1x

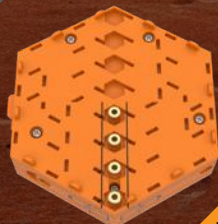

P2

1x



P1

2x

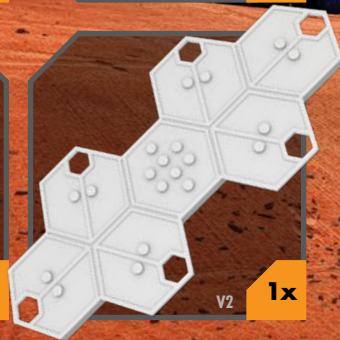

V2

1x

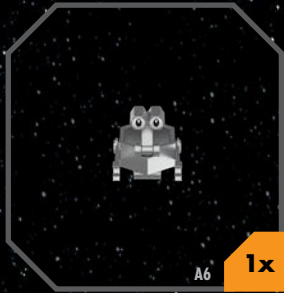

3X AAA

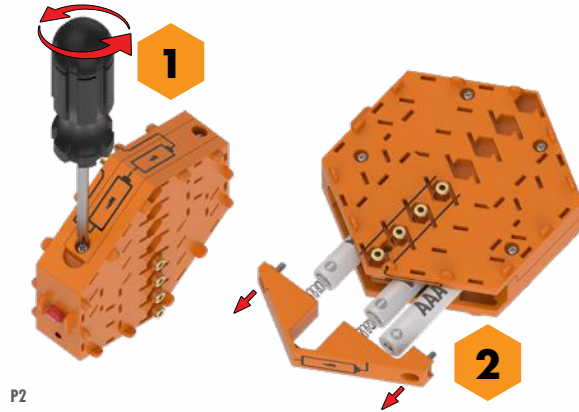

3X AAA

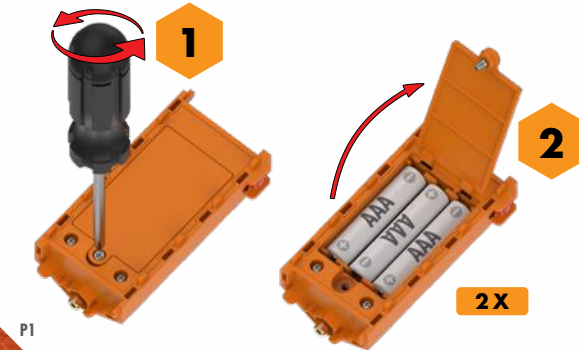

Battery Installation and Instructions

1. Use a Phillips-head screwdriver to remove the battery door screws.
2. Battery packs require three AAA batteries each, not included.
3. Batteries must be inserted with the correct polarity.
4. Do not mix old and new batteries.
5. Do not recharge non-rechargeable batteries.
6. Do not mix different types of batteries: alkaline, standard (carbon zinc), or rechargeable batteries.
7. Only use batteries of the same or equivalent type.
8. Remove exhausted batteries from the units.
9. Do not short-circuit the supply terminals.
10. Only charge rechargeable batteries under adult supervision.
11. Remove rechargeable batteries from the toy before charging.
12. This toy is not to be connected to more than the recommended number of power supplies.

To prevent corrosion and possible damage to the product, it is recommended to remove the batteries from the units if they will not be used for more than two weeks.

Conductive Parts

Power Source



These parts are where energy is stored.

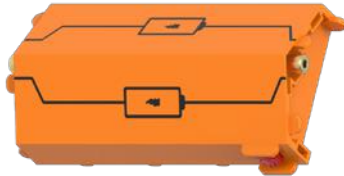

Conductor



These parts extend your builds and allow power to flow from the battery to the effect.

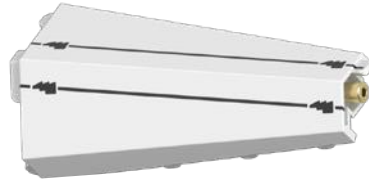

Effect



The various lights in this set are powered by the energy.



Read all instructions before using your Circuit Explorer™ set and keep this guide for reference.

WARNING: SHOCK HAZARD - Never touch the circuit connectors to outlets or anything else electrical in your home. Circuit components are only intended for use with other Circuit Explorer products, as described in this guide.

Attention Adults:

- Seek medical attention immediately if batteries or parts are swallowed. Have physician call the NATIONAL BATTERY INGESTION HOTLINE for advice and follow-up: (202) 625-3333 collect day or night.
- Do not use components in or near water.
- Do not put any components in mouth, eyes, or nose.
- Keep battery pack and other components away from AC power plugs and outlets
- Remove worn, dead, or corroded batteries immediately and discard properly.
- Please read all instructions and help your child follow each mission's steps and safety procedures.

Building a Circuit

Line up the battery with a conductor and the effect. When connected, these are ready to become a closed circuit.

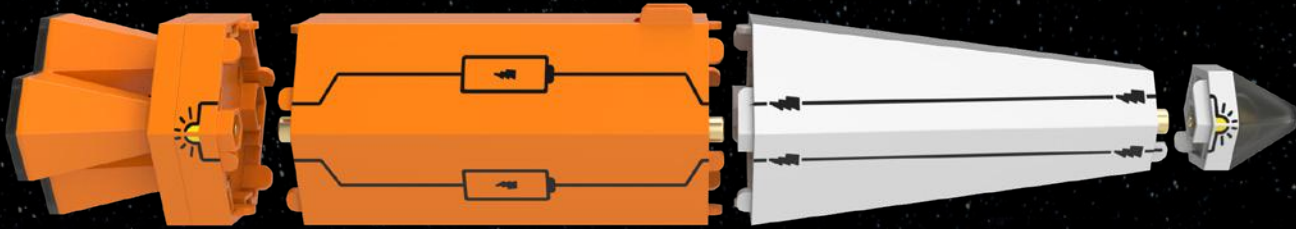

After the parts are connected, press the power button.
The depressed button closes the loop, allowing the energy to flow. This is a closed circuit!

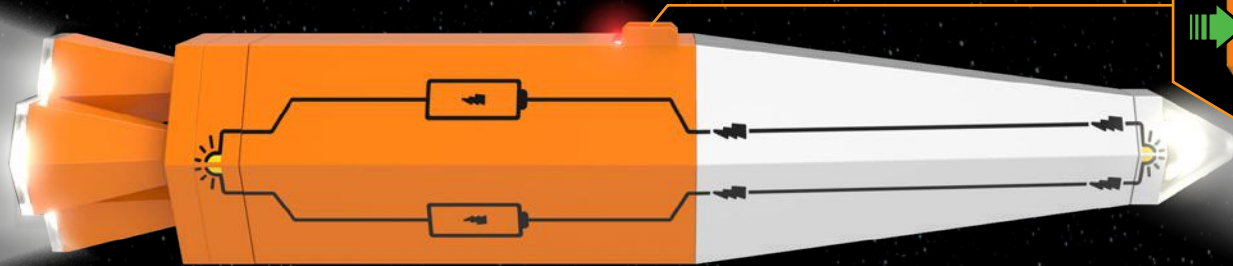
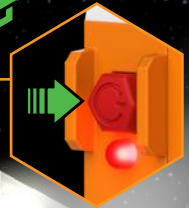

Line up the conductive symbols to make a complete loop.



Astronaut

1

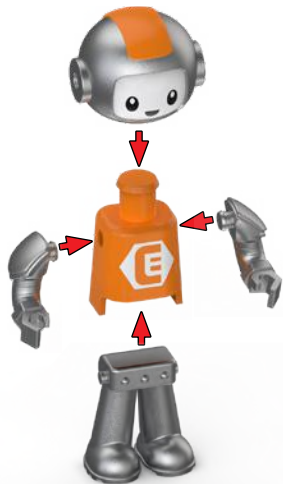

2



Robot

1

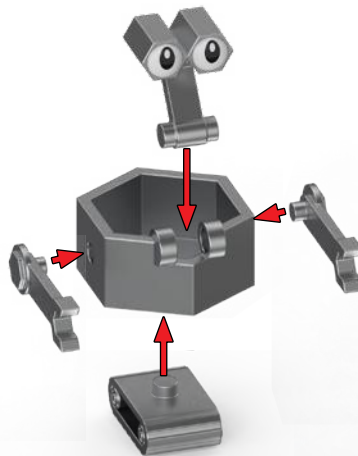

2

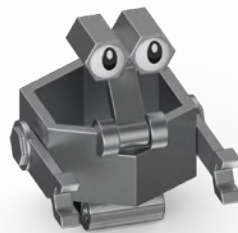



1

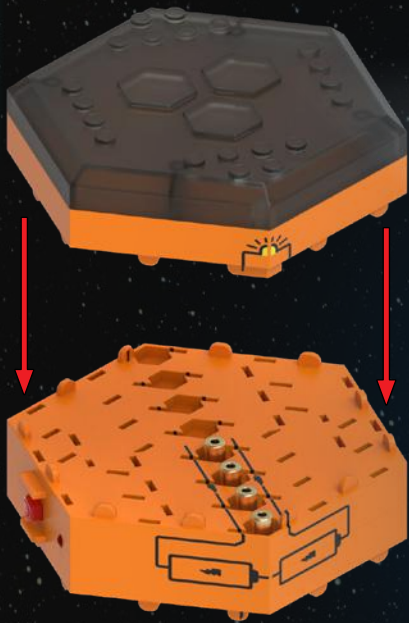

2



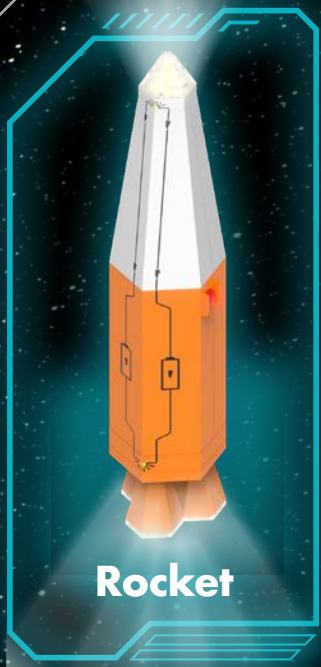

1

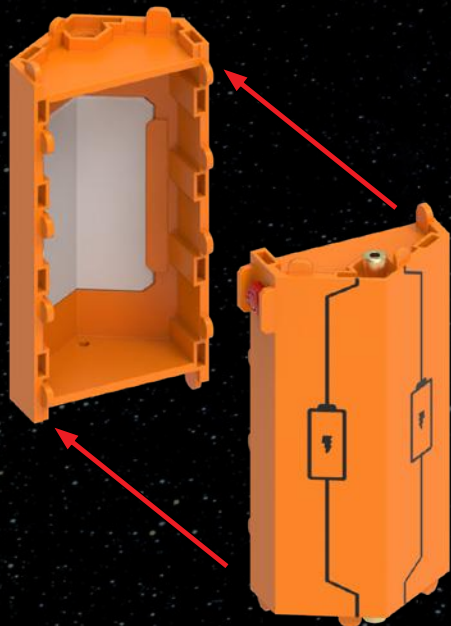

2

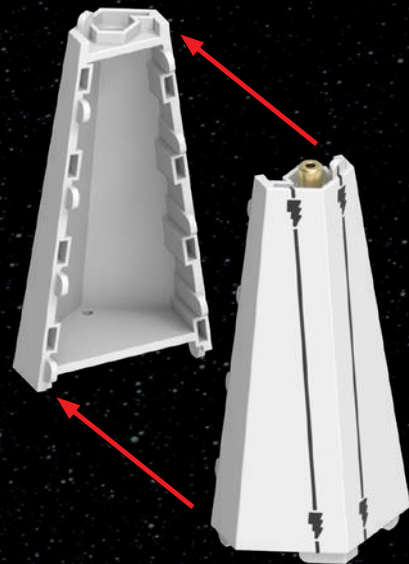

3

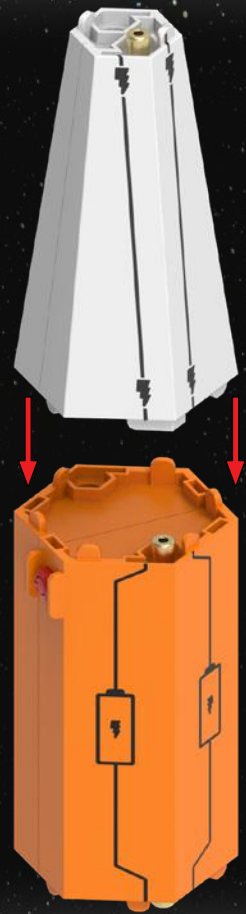

4

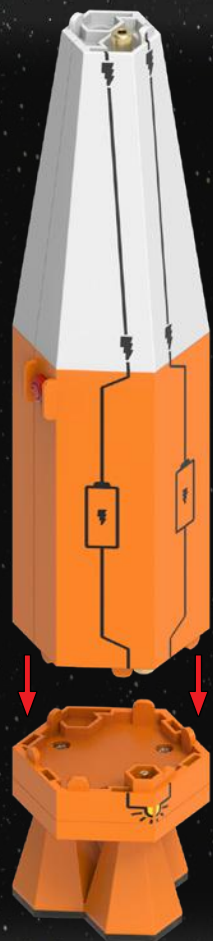

5

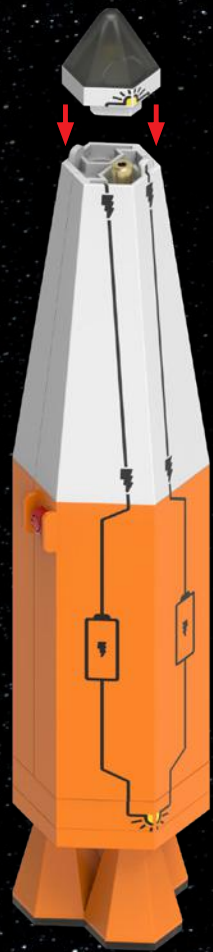

6

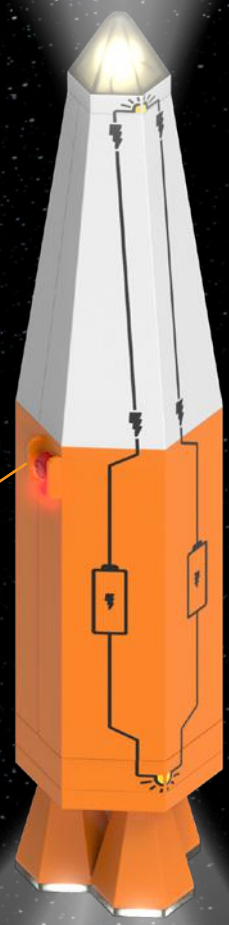
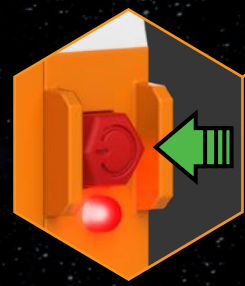

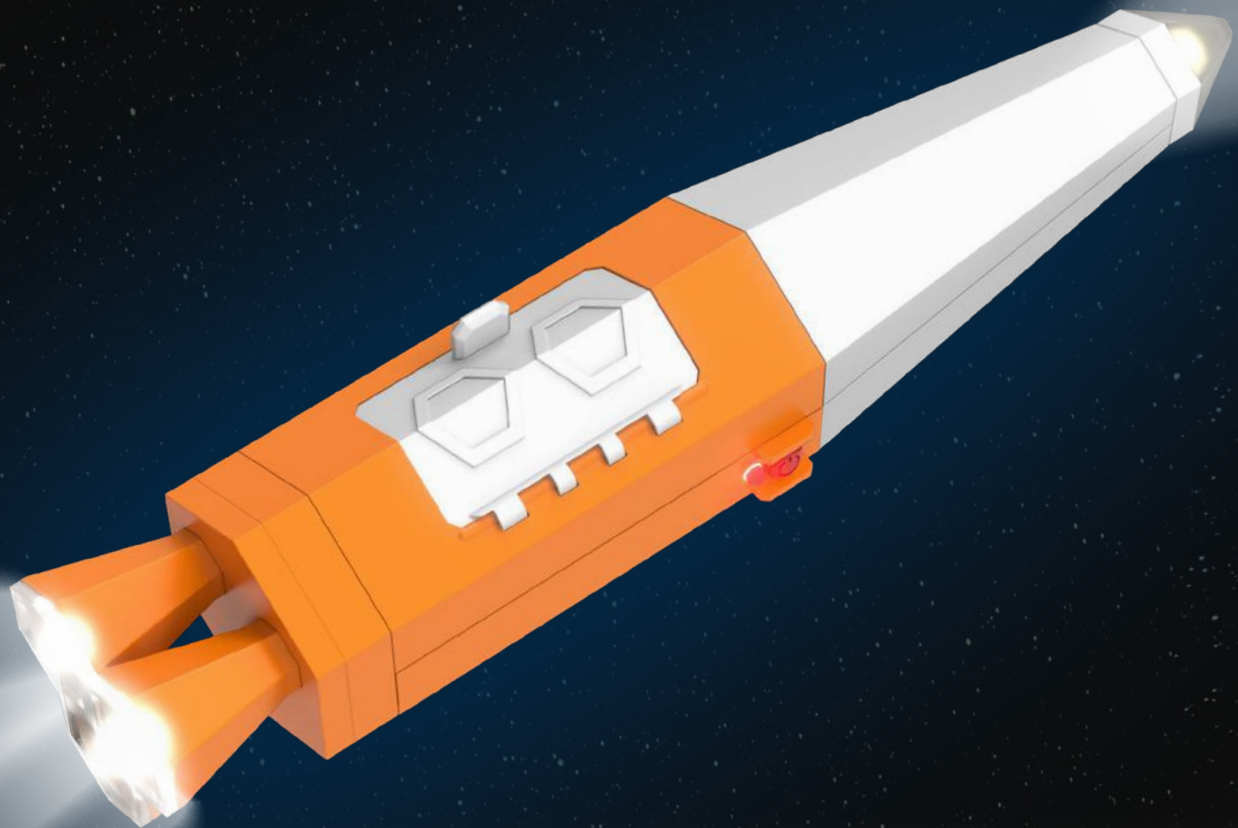



Rover 1

1

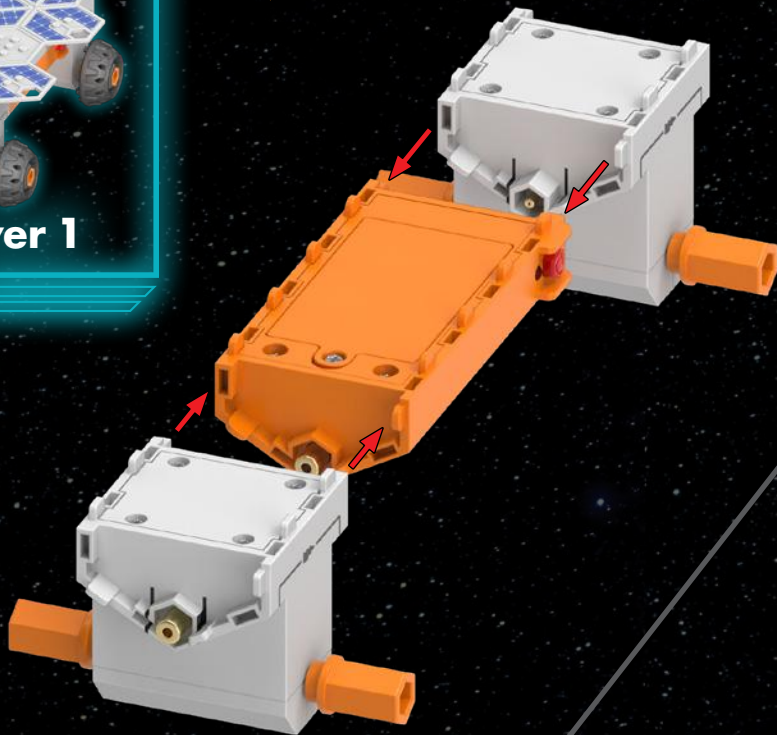

2

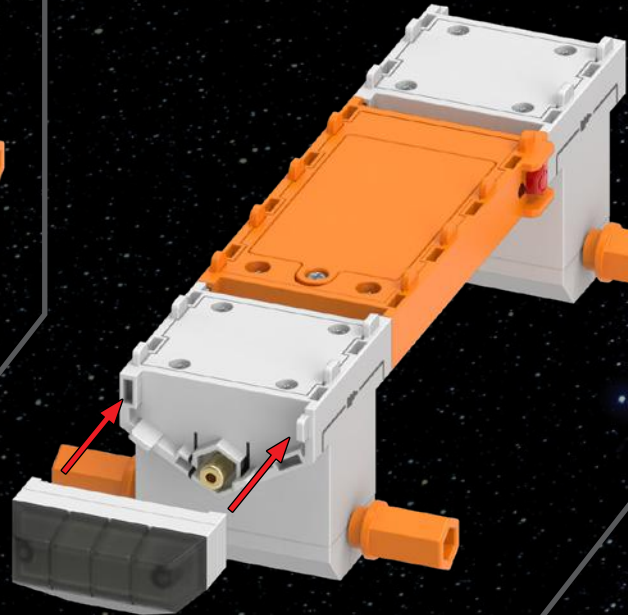

3

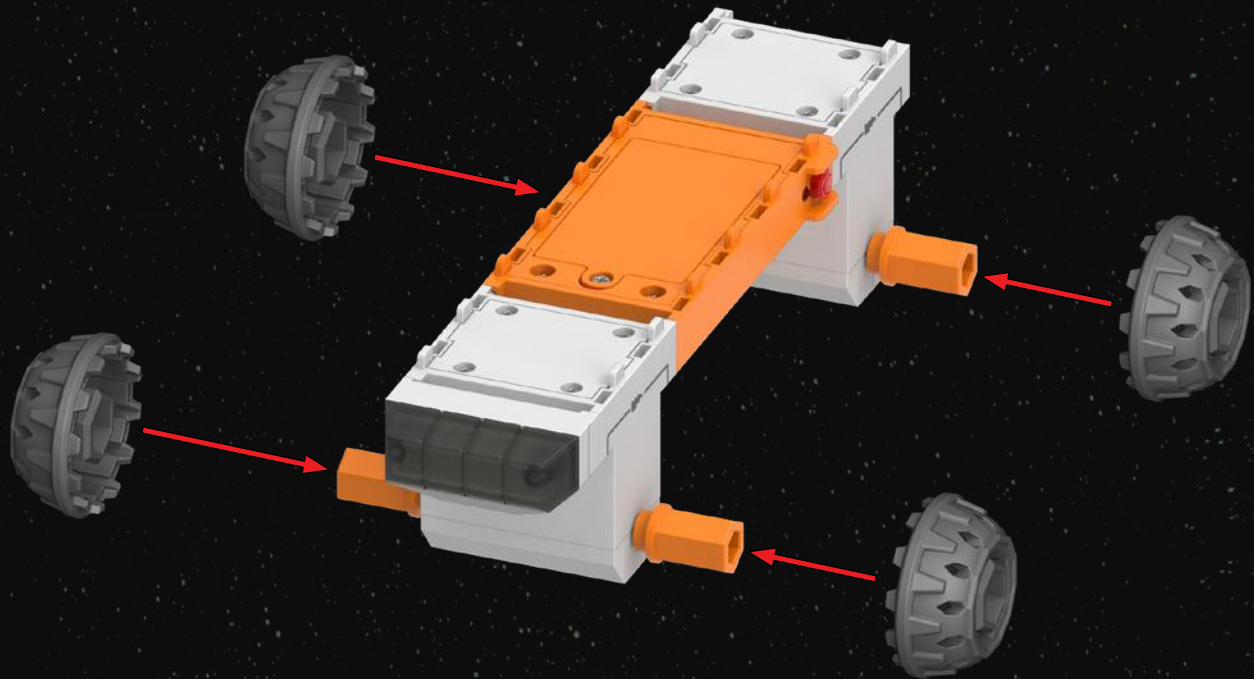

4

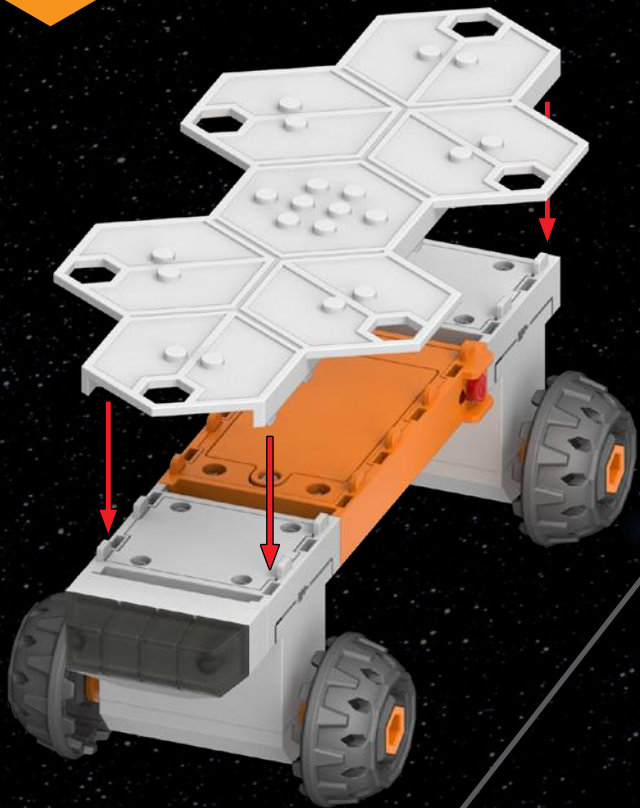

5



6

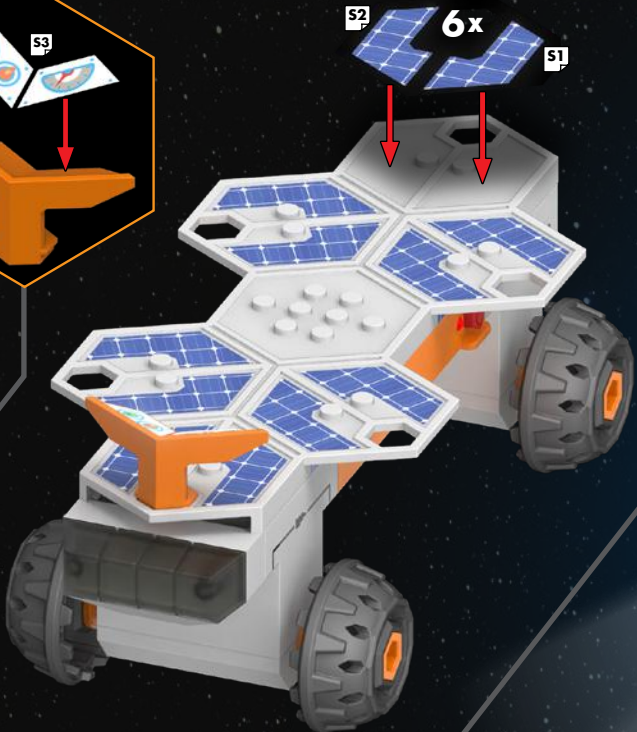
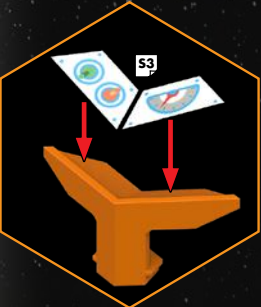

7

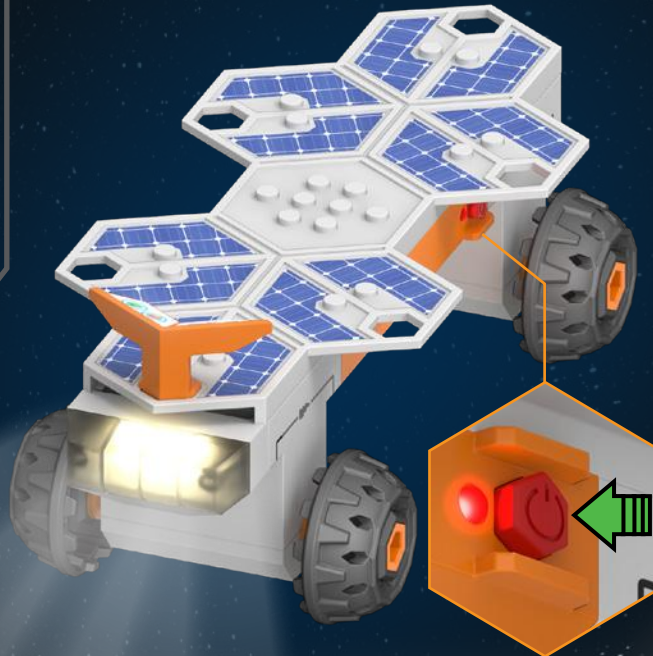

SURFACE TO SHIP TRANSPORT STATION



Mission: Invention!

You only have so many supplies at the outpost, so take apart your builds to create brand new inventions that will help you on your mission.

Good luck, Explorer!



**SOLAR
SCOOTER**

**CARGO
SHUTTLE**

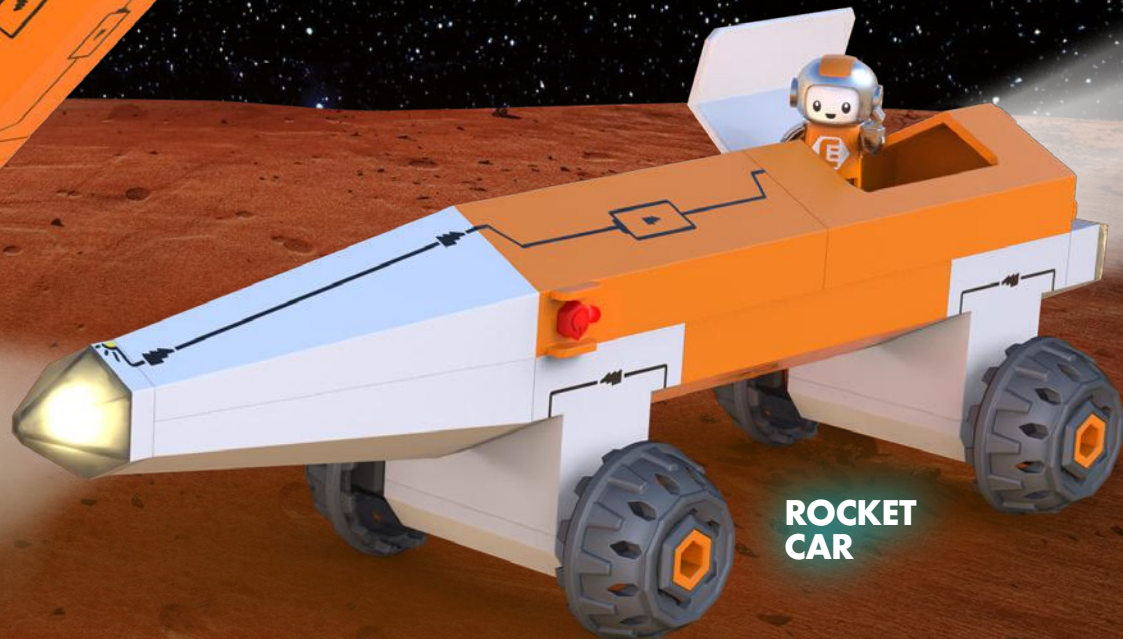

**ROCKET
CAR**

Connect to Explore More



For powered-up ideas and free activities visit:
www.educationalinsights.com/circuitexplorer



Share your creations with us using hashtag:
#circuitexplorer

Developed in Southern California by Educational Insights.
All rights reserved. Made in China. ©Educational Insights, Gardena, CA, USA.
Learning Resources Ltd., Bergen Way, King's Lynn, Norfolk, PE30 2JG, UK.
educationalinsights.com

Please retain the package for future reference.
Conserva el envase para futuras consultas.
Veuillez conserver l'emballage.
Bitte Verpackung gut aufbewahren.



This device complies with Part 15 of the FCC rules.
Operation is subject to the following two conditions:
(1) this device may not cause harmful interference and
(2) this device must accept any interference received,
including interference that may cause undesired operation.

ADVERTENCIA: PELIGRO DE ATRAGANTAMIENTO.
Partes pequeñas. No conviene para niños menores de tres años.
ATTENTION: DANGER D'ÉTOUFFEMENT.
Petites éléments. Ne convient pas aux enfants de moins de trois ans.
ACHTUNG: ERSTICKUNGSGEFAHR.
Kleine Teile. Nicht für Kinder unter drei Jahren geeignet.