

EI-4202

6+

SIMPLE CIRCUITS | BIG IMAGINATION

# CIRCUIT EXPLORER™

DELUXE

BASE STATION

MISSION GUIDE



**WARNING:**

CHOKING HAZARD—Small parts.  
Not for children under three (3) years.



0-3



**WARNING:**

This toy produces flashes that may  
trigger epilepsy in sensitized individuals.





# Welcome Explorers!

You made it to Mars! Your assignment is to construct a Base Station, which will serve as our central command post. The site is equipped with supplies to build the things you will need.

Your team will explore the far reaches of the planet, search for signs of life, and conduct vital experiments. Be sure to radio your findings back to Mission Control on Earth. Follow these instructions to build two specialized rovers, a Command Center, Communication Tower, and Commissary where you can eat.

We are relying on your engineering skills to create closed circuits and propel our mission forward!

Good Luck!

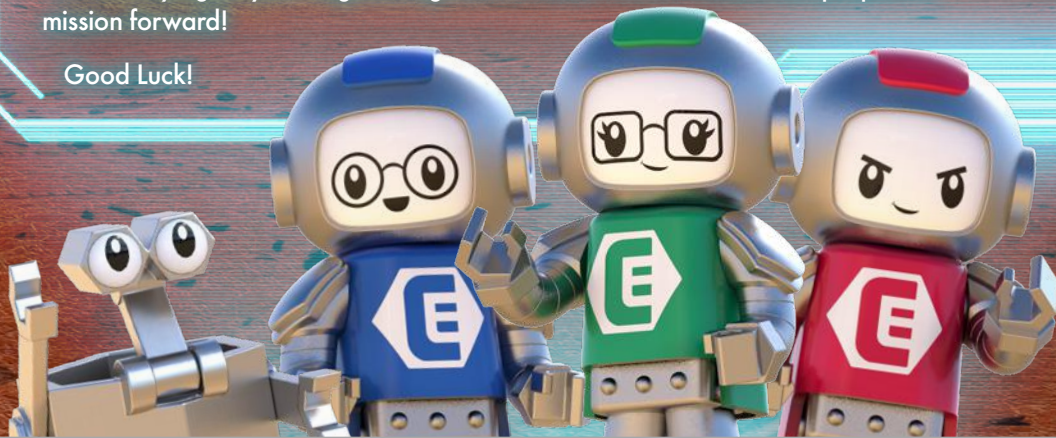

# Parts Checklist



STICKERS 1x

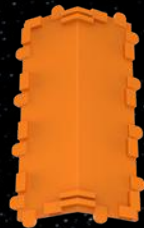

B1 4x



A13 2x



L3 2x

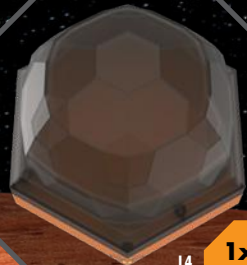

L4 1x



A7 1x



A9 1x



A11  
A12 1x



P1 1x



C8 2x



N1 2x



P2 3x



N7 7x

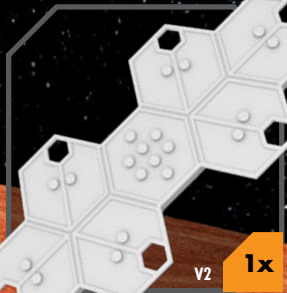
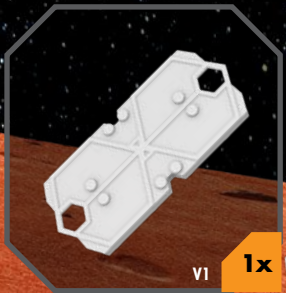
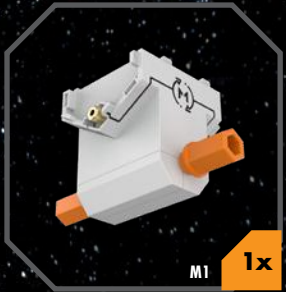
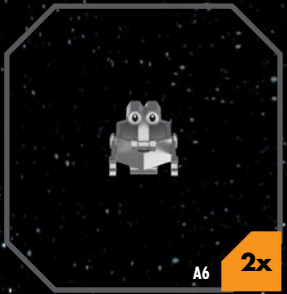
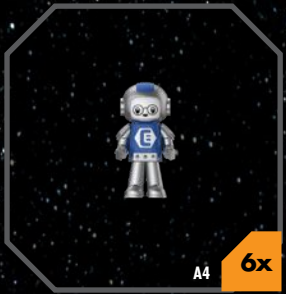

# Conductive Parts

## Power Source



These parts are where energy is stored.

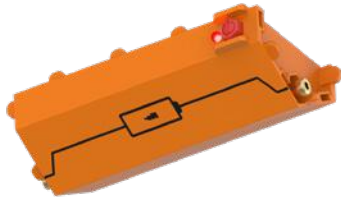

## Conductor



These parts extend your builds and allow power to flow from the battery to the effect.



## Effect



The various lights and motors in this set are powered by the energy.

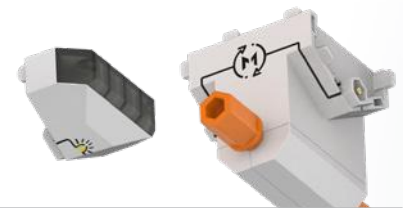

**Read all instructions before using your Circuit Explorer™ set and keep this guide for reference.**

**WARNING: SHOCK HAZARD** - Never touch the circuit connectors to outlets or anything else electrical in your home. Circuit components are only intended for use with other Circuit Explorer products, as described in this guide.

### Attention Adults:

- Seek medical attention immediately if batteries or parts are swallowed. Have physician call the NATIONAL BATTERY INGESTION HOTLINE for advice and follow-up: (202) 625-3333 collect day or night.
- Do not use components in or near water.
- Do not put any components in mouth, eyes, or nose.
- Keep battery pack and other components away from AC power plugs and outlets
- Remove worn, dead, or corroded batteries immediately and discard properly.
- Please read all instructions and help your child follow each mission's steps and safety procedures.

# Building a Circuit

Line up the power source with a conductor and the effect. When connected, these are ready to become a closed circuit.

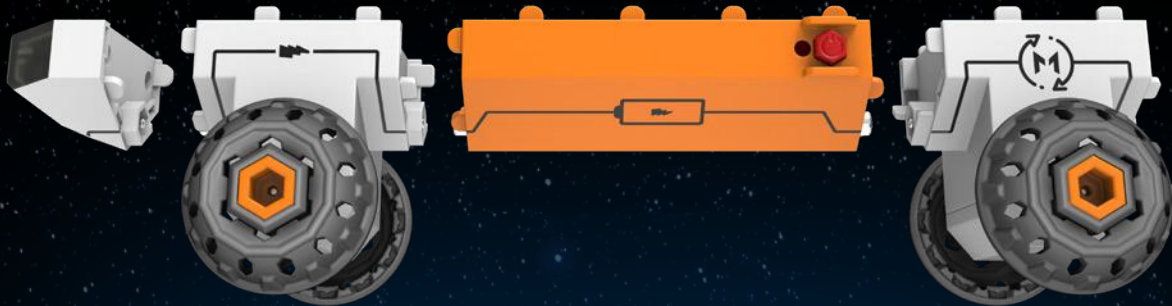

After the parts are connected, press the power button. The depressed button closes the loop, allowing the energy to flow. This is a closed circuit!

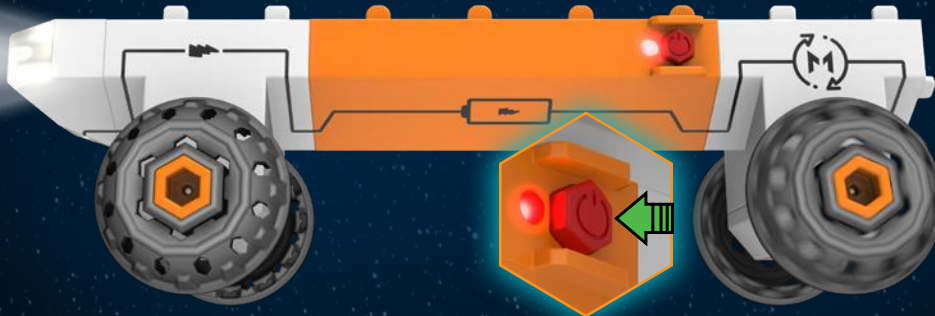

Line up the conductive symbols to make a complete loop.

## Battery Installation and Instructions

1. Use a Phillips-head screwdriver to remove the battery door screws.
2. Battery packs require three AAA batteries each, not included.
3. Batteries must be inserted with the correct polarity.
4. Do not mix old and new batteries.
5. Do not recharge non-rechargeable batteries.
6. Do not mix different types of batteries: alkaline, standard (carbon zinc), or rechargeable batteries.
7. Only use batteries of the same or equivalent type.
8. Remove exhausted batteries from the units.
9. Do not short-circuit the supply terminals.
10. Only charge rechargeable batteries under adult supervision.
11. Remove rechargeable batteries from the toy before charging.
12. This toy is not to be connected to more than the recommended number of power supplies.

To prevent corrosion and possible damage to the product, it is recommended to remove the batteries from the units if they will not be used for more than two weeks.

### P1 3X AAA



### P2 3X AAA

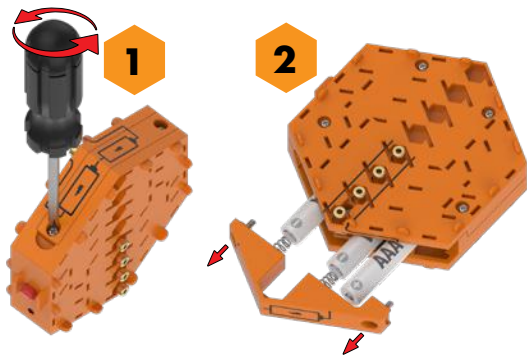

### A7 3X AAA

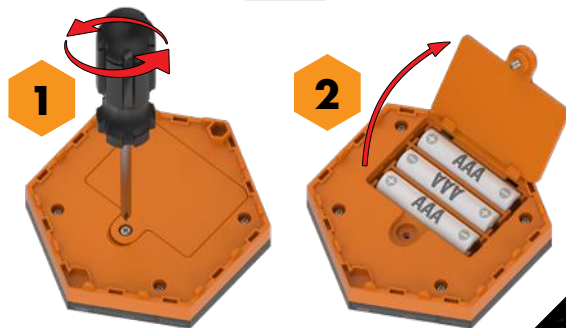





## Astronaut

1

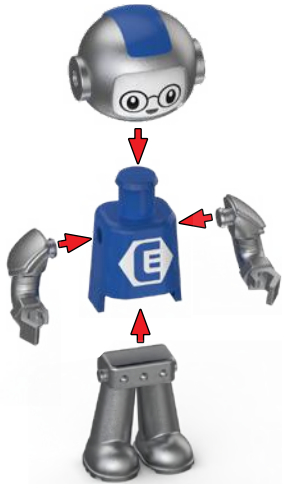

2



## Robot

1

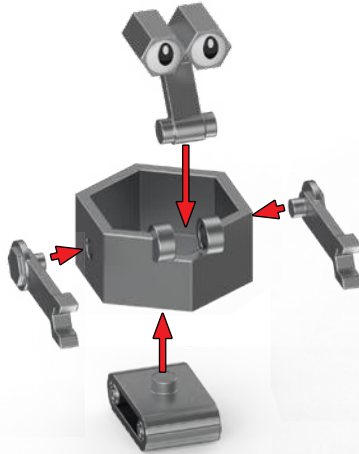

2





Explorer Rover X

1

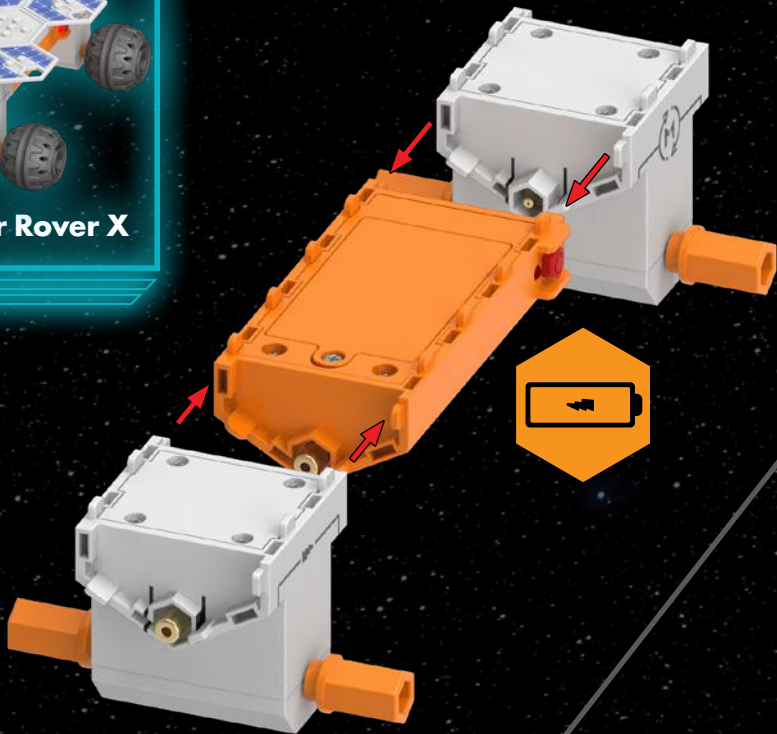

2

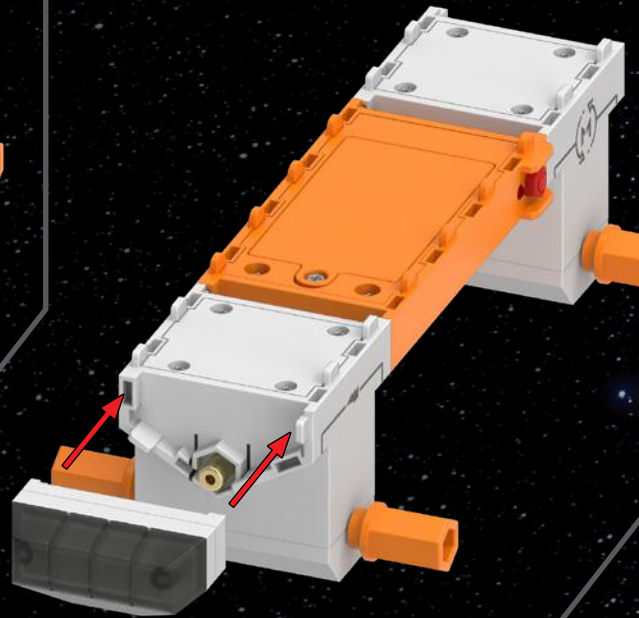

3

X4

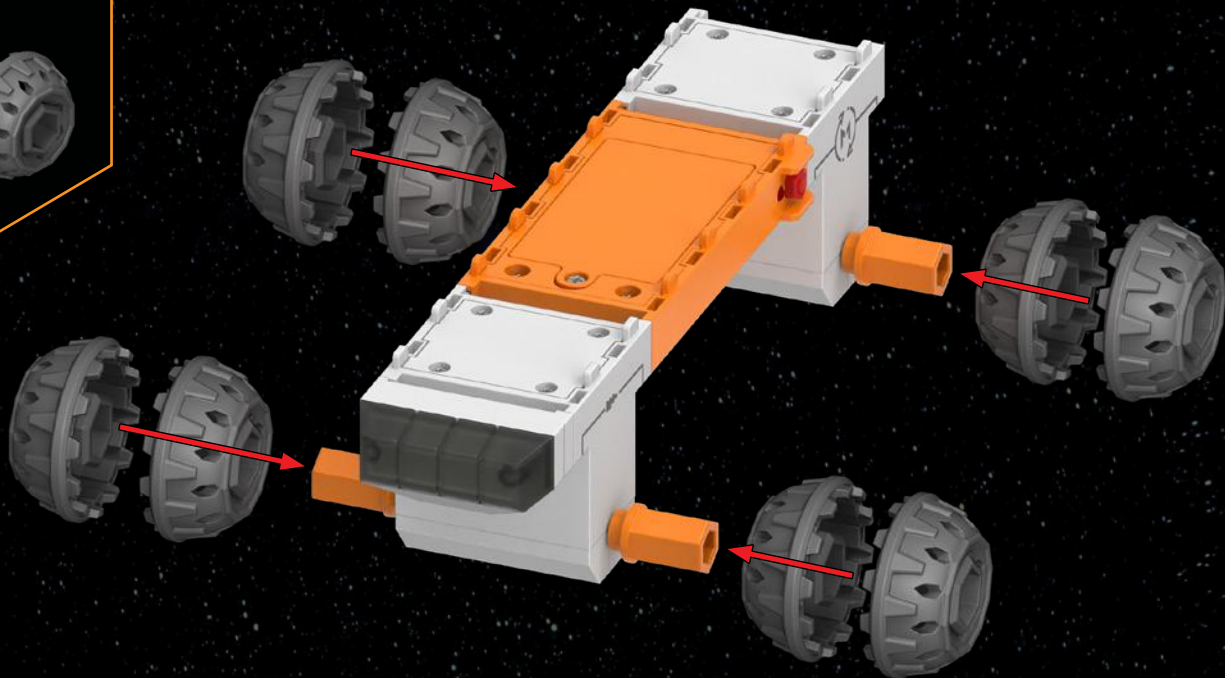

4

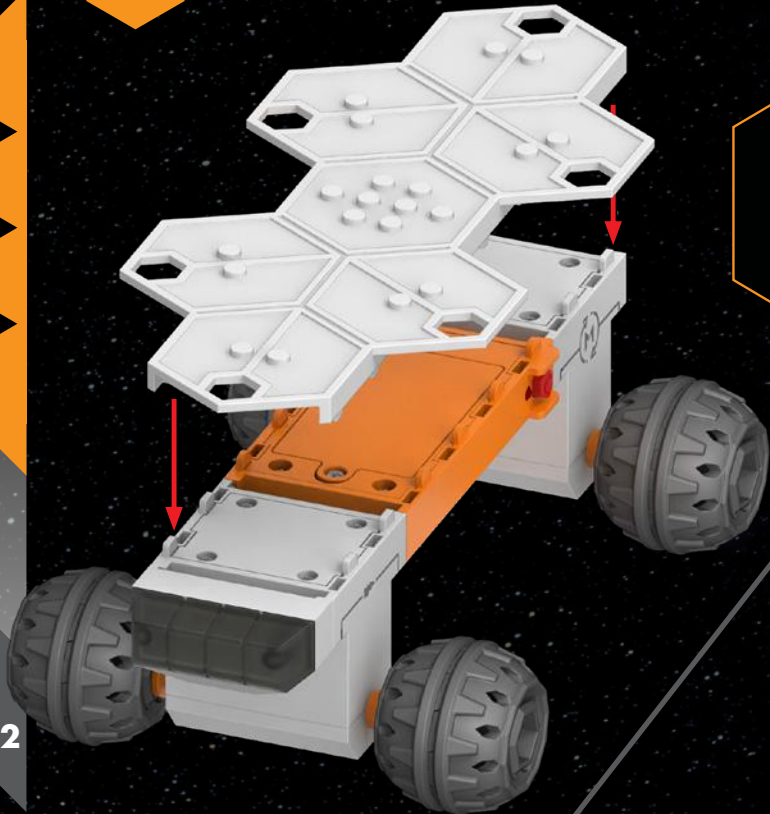

5

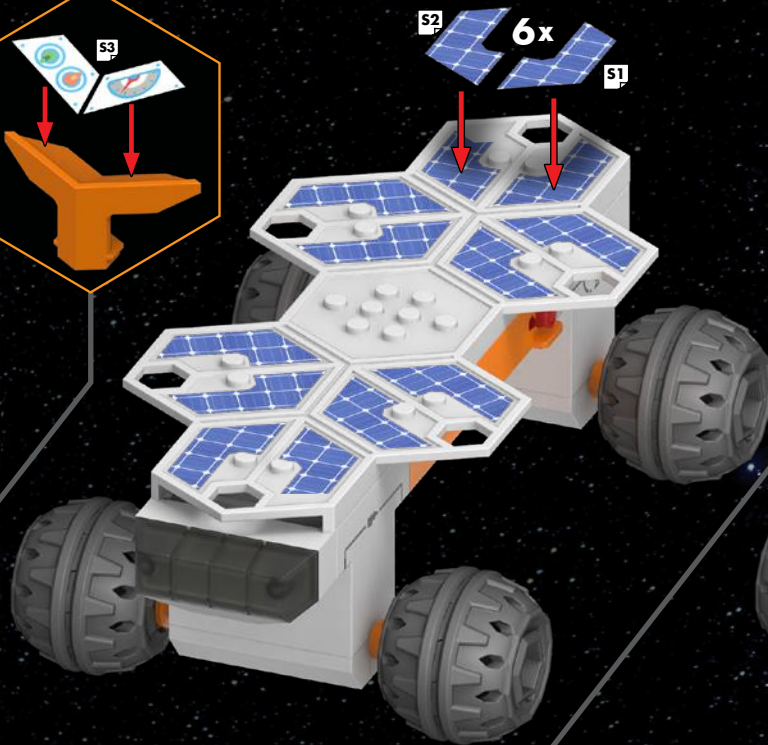

6

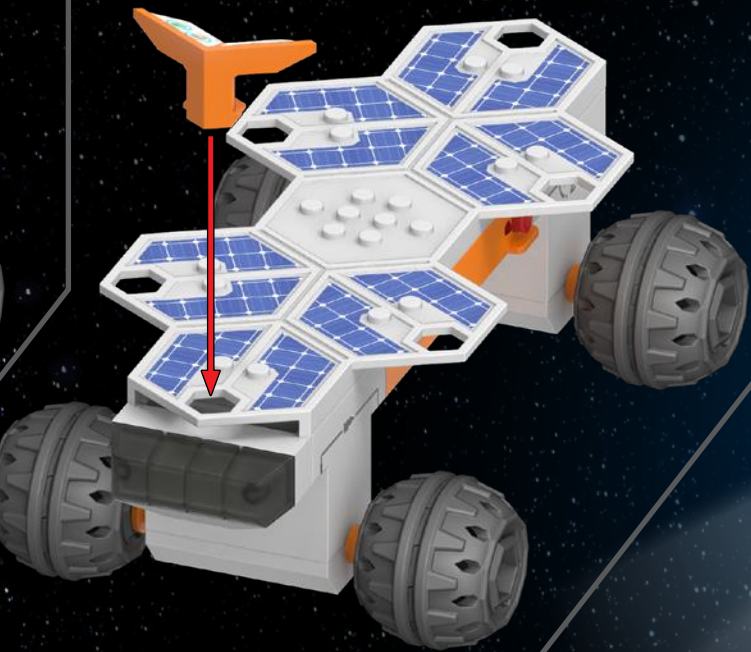

7

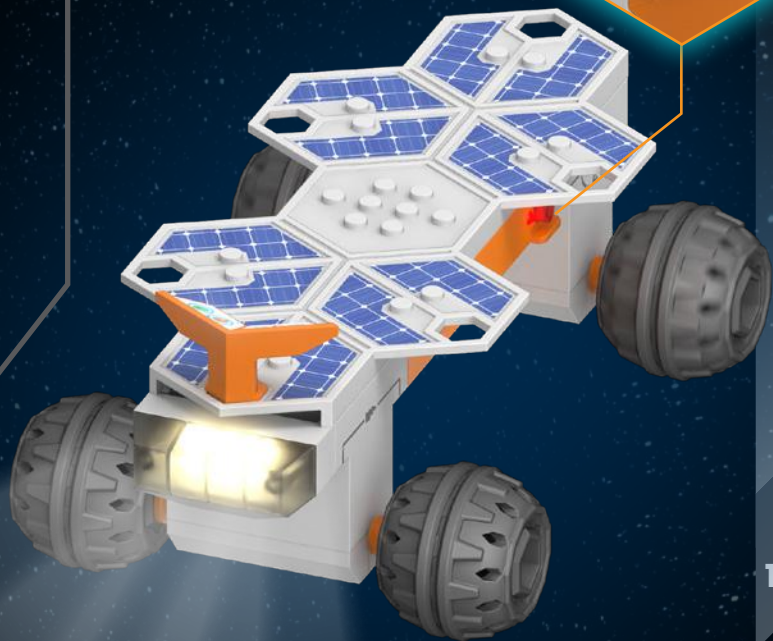



1

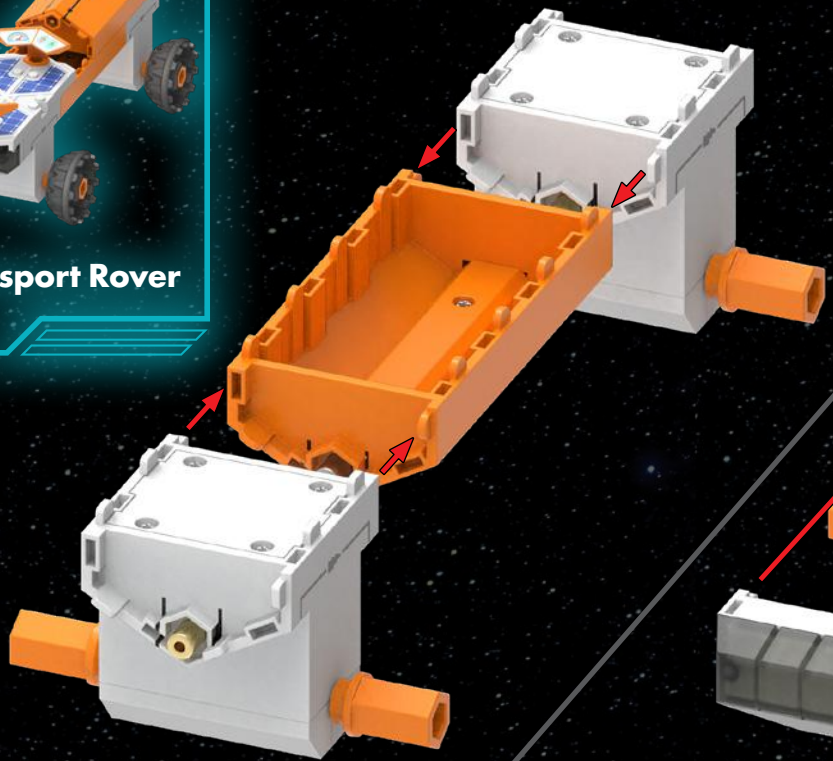

2

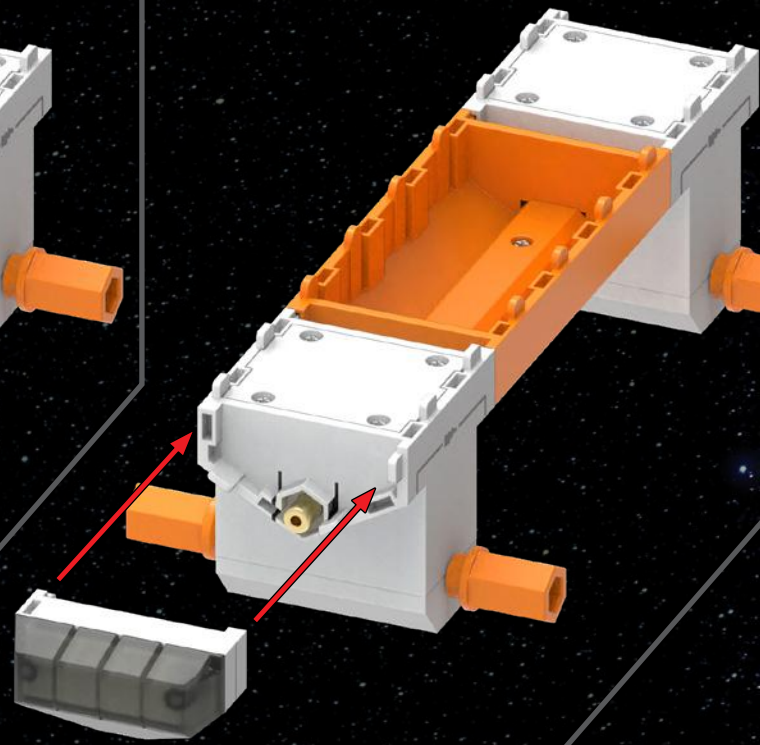

3

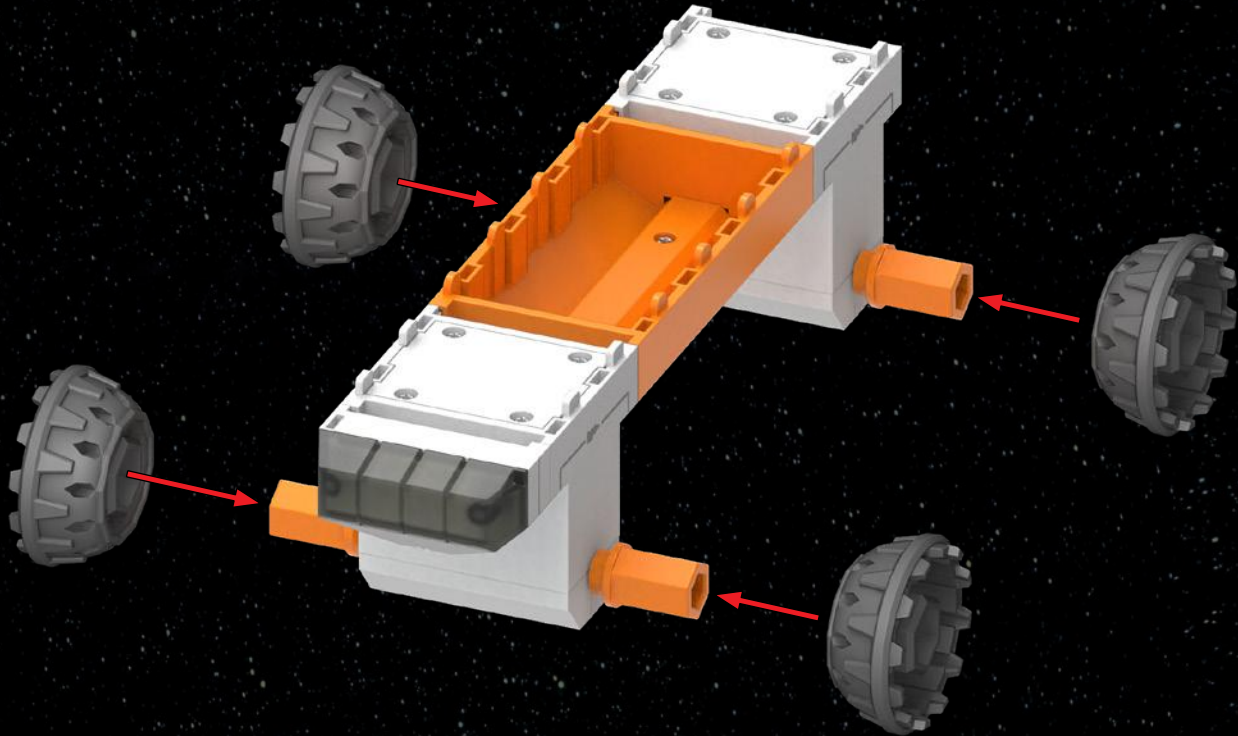

4

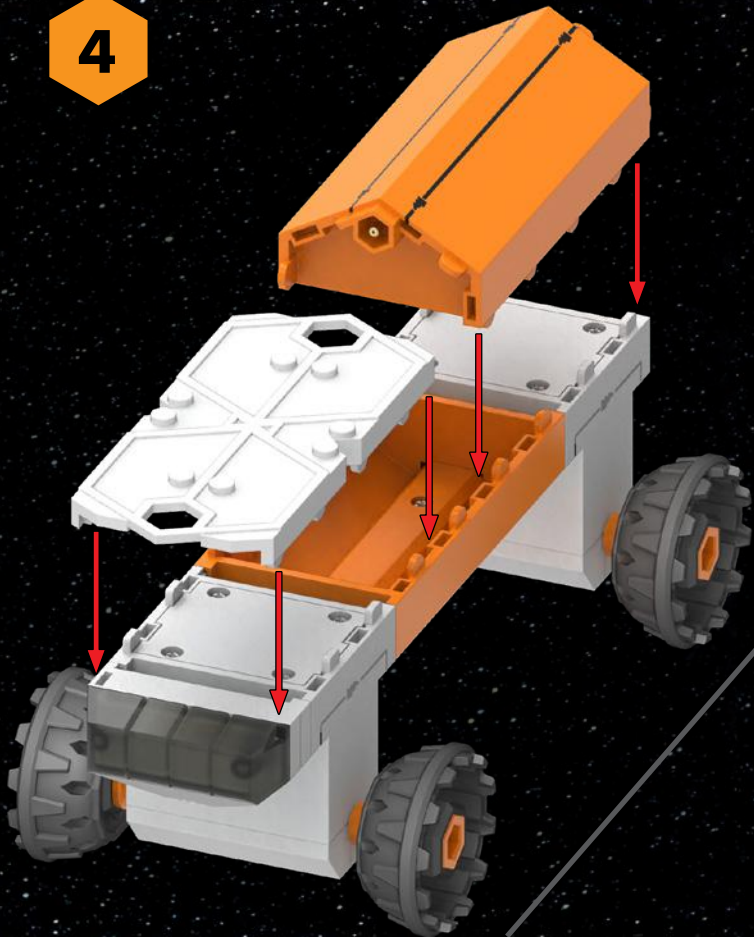

16

5

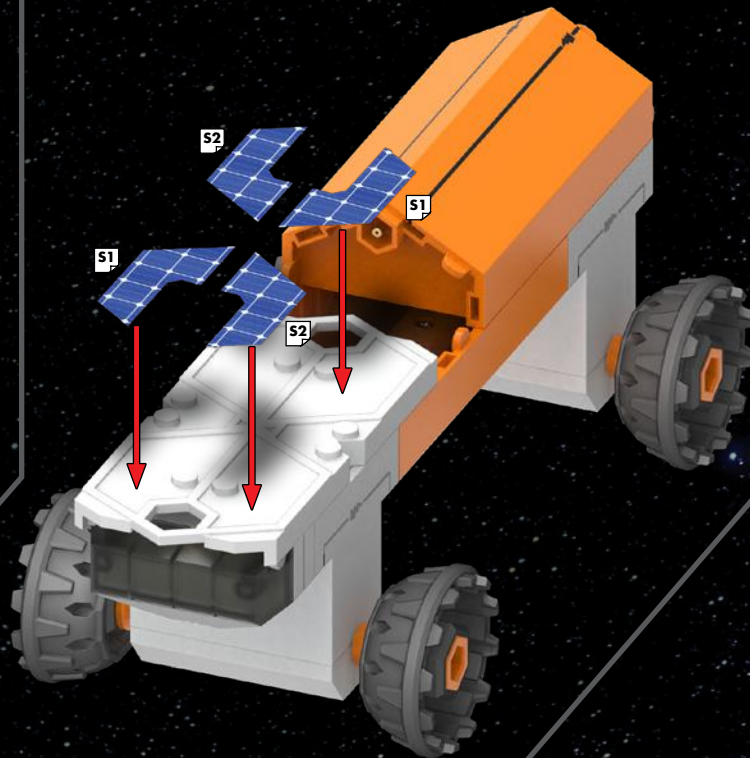



6

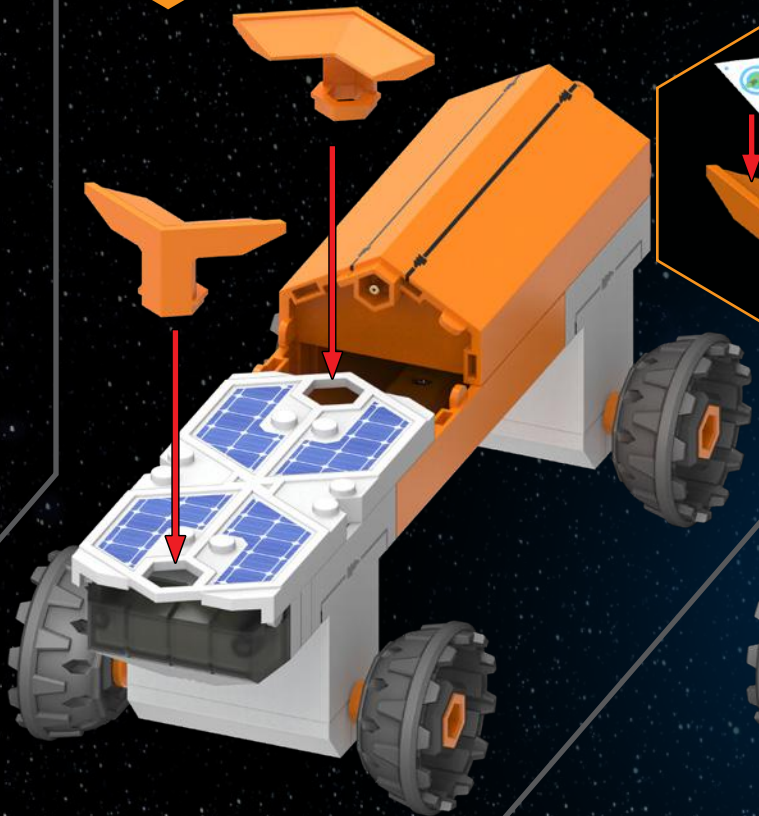

7

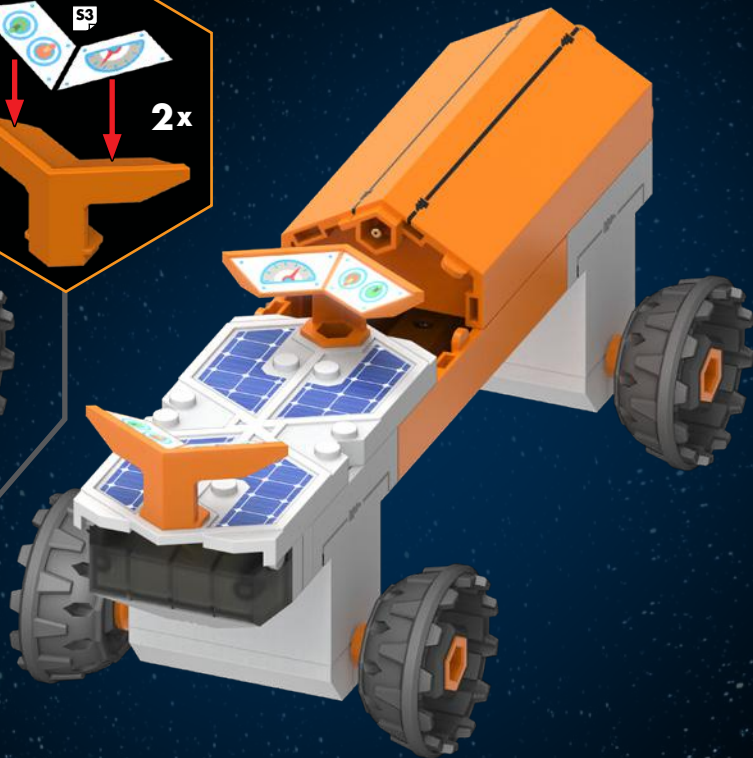



**Comms Tower**

**1**

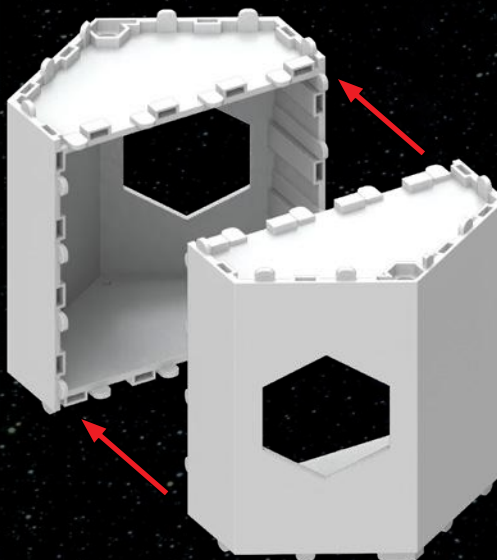

**2**



3



4

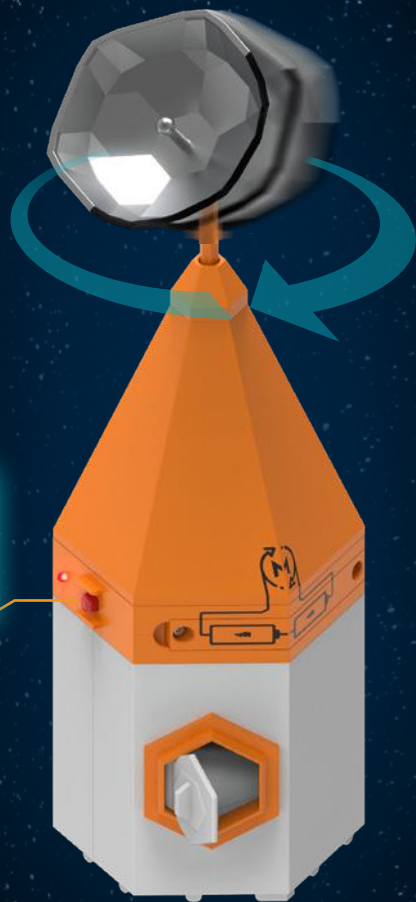
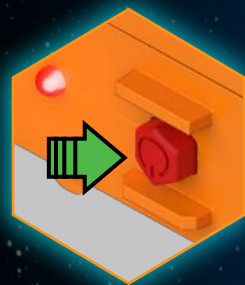

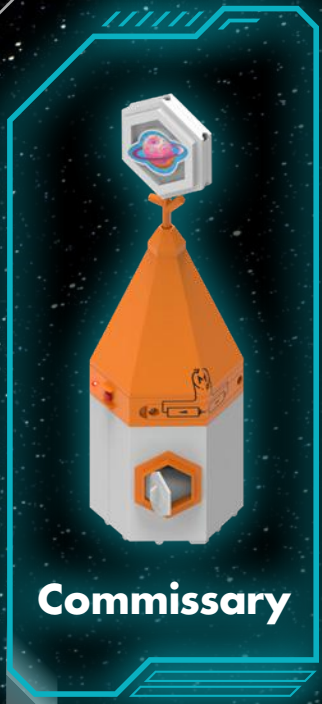

**Commissary**

20

**1**

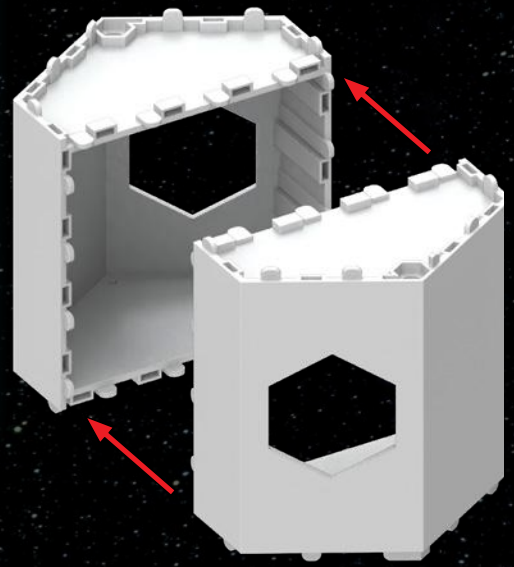

**2**

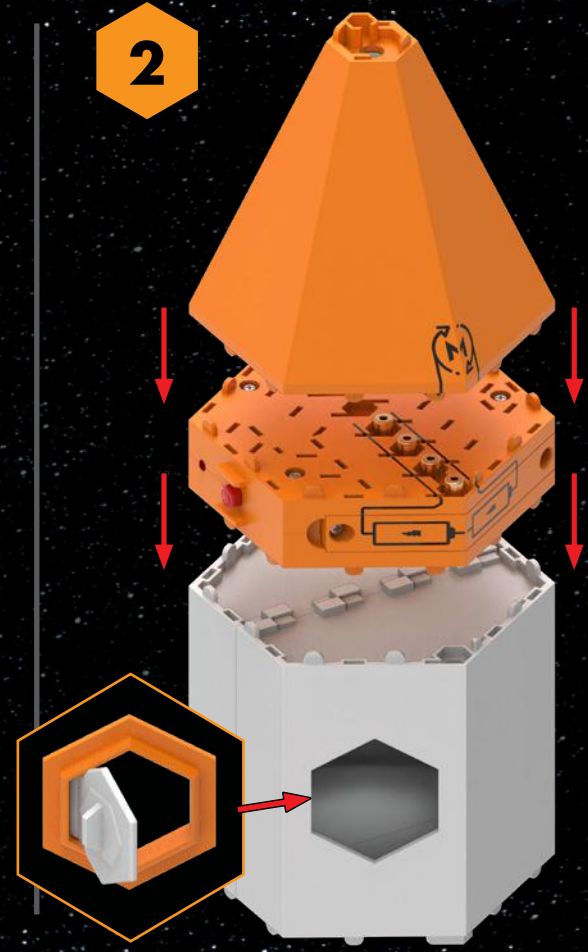

3

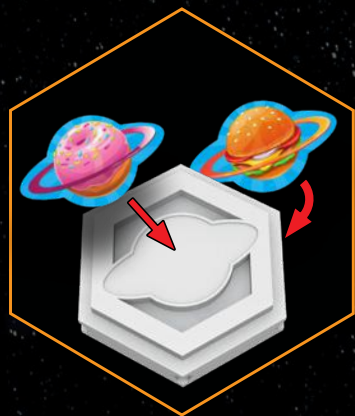
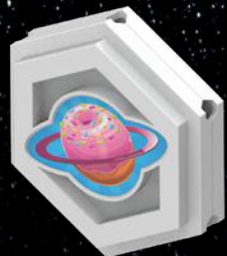

4

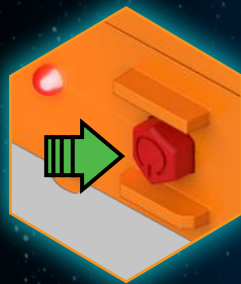



**1**

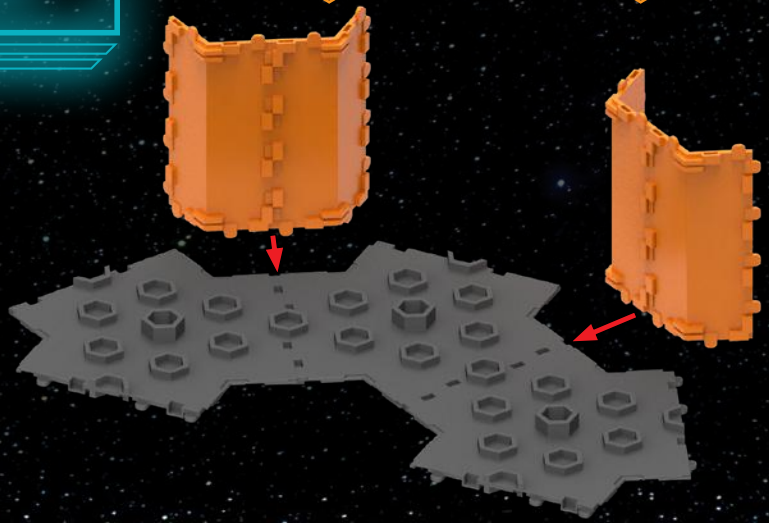
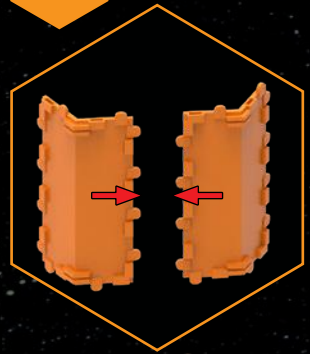

**2**

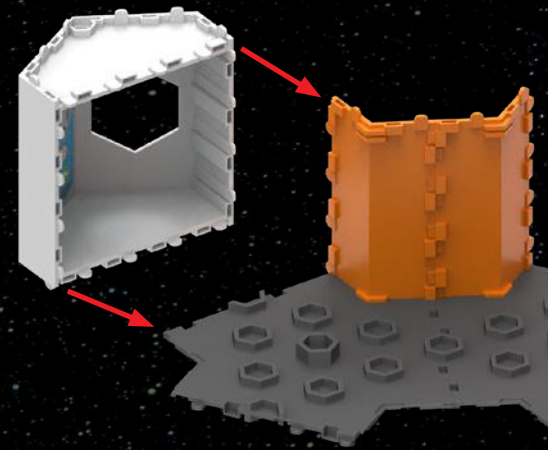

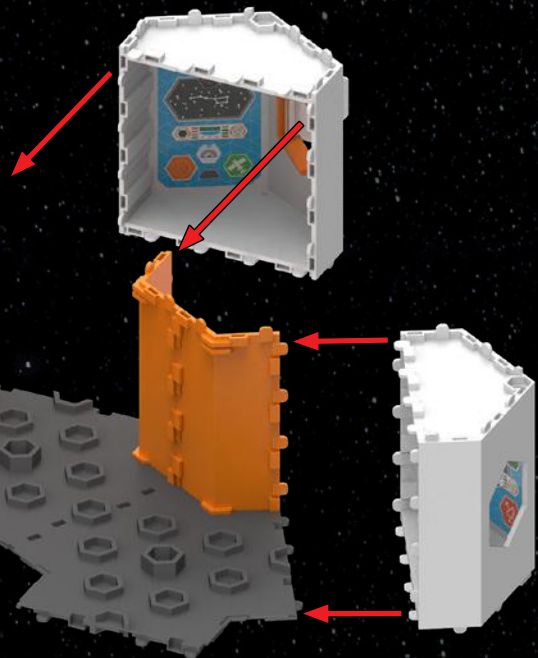

**3**

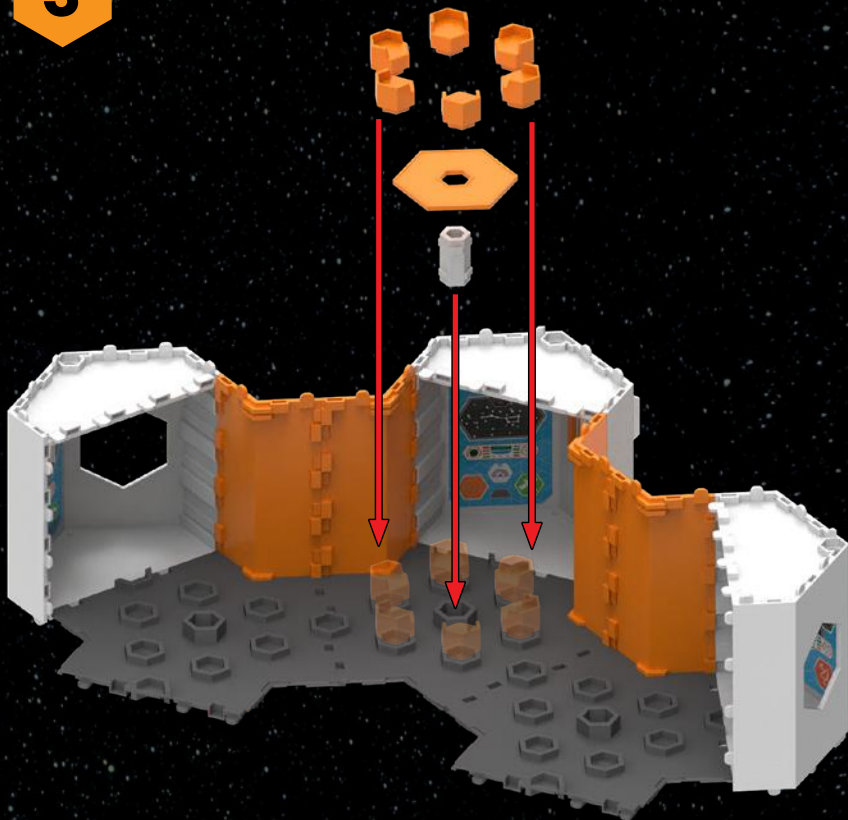

4



5





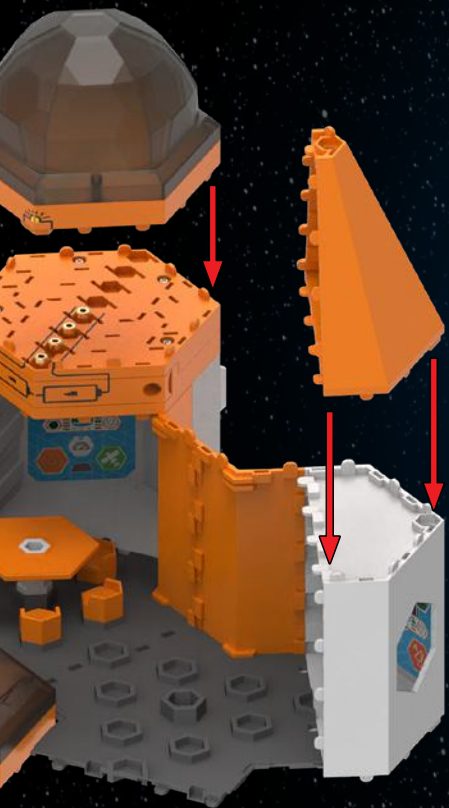

6

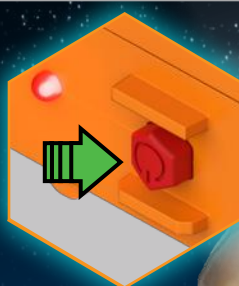

P. 28

5

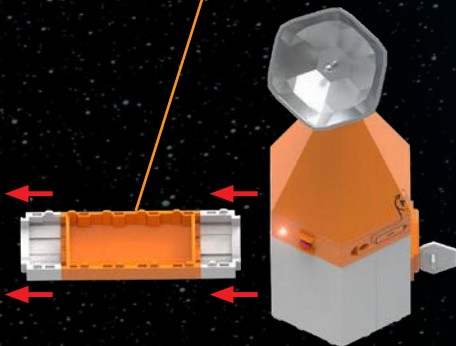
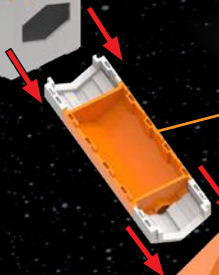
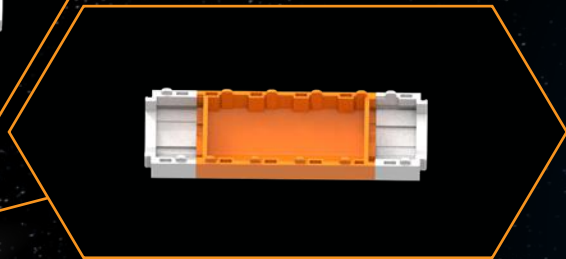
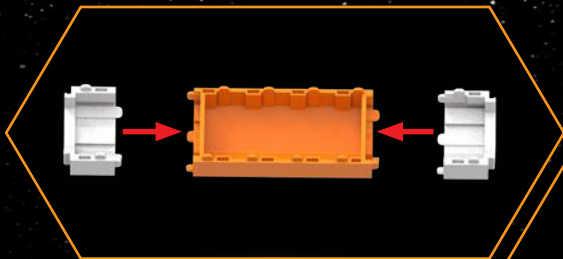



# THE SOUND BOX



## Power On/Off

Press to turn on.  
Press again to turn off.

Record



Sound Effects



Play

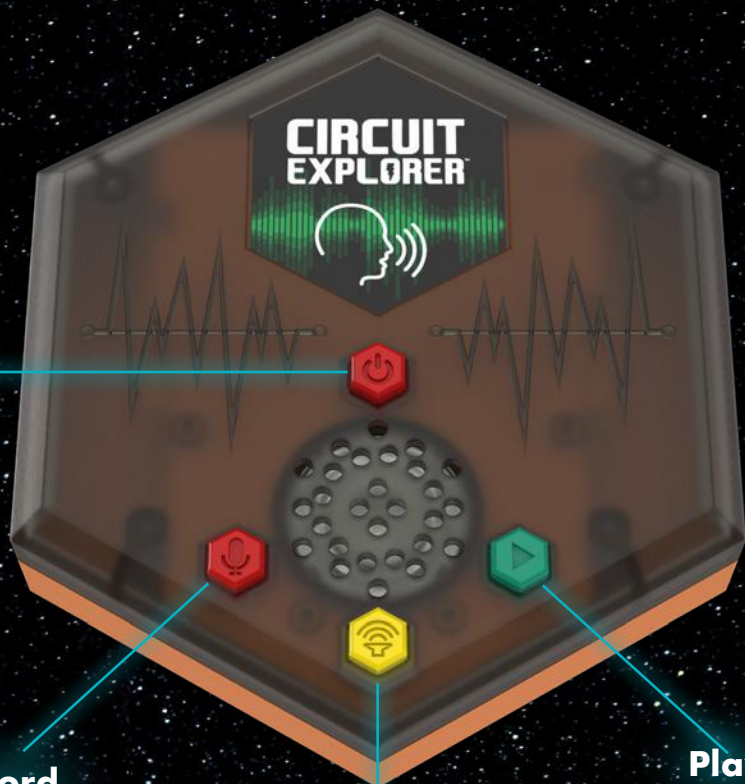

## Record



**Press and hold.  
Speak into the speaker.  
Let go when done.**



## Play



**Play back your recording  
to hear your synthesized  
space voice.**

## Sound Effects



**Press to play cosmic  
sounds recorded at  
the Base.**

# Mission: Invention!

You only have so many supplies at the station, so take apart your builds to create brand new inventions that will help you on your mission.

Good luck, Explorers!

30



CITADEL



CROW'S NEST

A LEGO Technic Hovercraft XL set, featuring a white base with blue Technic plates and orange Technic walls. Two minifigures are on board: one in an orange suit with a white 'E' on the chest, and another in a red suit with a white 'E' on the chest. The set is shown floating in space.

**HOVERCRAFT XL**

A LEGO Technic Star Deck set, featuring two white towers with orange conical roofs. The towers are connected by a white Technic beam. Two minifigures are on the deck: one in a silver suit with a white 'E' on the chest, and another in a yellow suit with a white 'E' on the chest. The set is shown on a brown, cratered surface.

**STAR DECK**

A LEGO Technic Light Pod set, featuring a white Technic pod with a yellow Technic top. A minifigure in a green suit with a white 'E' on the chest is inside. The pod is shown on a brown, cratered surface.

**LIGHT POD**

# Connect to Explore More



For powered-up ideas and free activities visit:  
[www.educationalinsights.com/circuitexplorer](http://www.educationalinsights.com/circuitexplorer)



Share your creations with us using hashtag:  
**#circuitexplorer**

Developed in Southern California by Educational Insights.  
 All rights reserved. Made in China. ©Educational Insights, Gardena, CA, USA.  
 Learning Resources Ltd., Bergen Way, King's Lynn, Norfolk, PE30 2JG, UK.  
[educationalinsights.com](http://educationalinsights.com)

Please retain the package for future reference.  
 Conserva el envase para futuras consultas.  
 Veuillez conserver l'emballage.  
 Bitte Verpackung gut aufbewahren.



This device complies with Part 15 of the FCC rules.  
 Operation is subject to the following two conditions:  
 (1) this device may not cause harmful interference and  
 (2) this device must accept any interference received,  
 including interference that may cause undesired operation.

**ADVERTENCIA: PELIGRO DE ATAGANTAMIENTO.**  
 Partes pequeñas. No conviene para niños menores de tres años.  
**ATTENTION: DANGER D'ÉTOUFFEMENT.**  
 Petites éléments. Ne convient pas aux enfants de moins de trois ans.  
**ACHTUNG: ERSTICKUNGSGEFAHR.**  
 Kleine Teile. Nicht für Kinder unter drei Jahren geeignet.